

# Installation & Commissioning Instructions

for Digital or Manual controller



## HEX390 Domestic Ventilation System with Heat Exchanger

Balanced Pressure Ventilation



# Contents

HEX390 Warranty	2
Pre-checks & Recommendations	3
Technical Data	4
Kit Contents	5
Installation Instructions	6-9
Hex Digital Wiring Schematic	9
Wiring schematic - Manual 3speed switch	10
Wiring schematic - Digital controller	11
Installer's recommended settings:	12
Trouble Shooting	12
Digital Controller - Commissioning Instructions	13
Digital Controller - Commissioning Instructions - Menu Options	14-15
User Operating Instructions	16



## HEX390 Warranty

5 years manufacturing warranty from date of first retail purchase.

This HEX product, when delivered to you in new condition from a HEX authorized dealer and used in normal conditions, will be free from any defects in manufacturing, materials and workmanship for the periods set out above ("Warranty Period"):

Any faulty goods will be repaired or replaced via the HEX dealer.

This warranty is for the manufactured product, it does not include installation or removal.

## WARRANTY RETURN

Upon installation, please send to the manufacturer, c/o PO Box 8358, Christchurch (on request by the dealer).

Purchaser: \_\_\_\_\_

Address: \_\_\_\_\_

Description: HEX390 \_\_\_\_\_

Serial number: \_\_\_\_\_

Purchased from / Dealer: \_\_\_\_\_

Dealer invoice number: \_\_\_\_\_

Date of installation: \_\_\_\_\_

Installed by: \_\_\_\_\_

**Please Note:** These installation and commission instructions are merely a set of guidelines for effective installation and setup of the system to yield maximum performance. Actual installation may vary due to the vast variety of the house architecture and climates. Ensure you fully understand this manual and plan ahead before commencing the work. Unit must be installed by a suitably qualified person and all electrical terminations must be carried out by a registered electrician to New Zealand standards.

**Pre-checks & Recommendations**

1. Before installation, ensure the system suits your requirements
2. Check that adequate heat sources are present for the optimum performance of the system.
3. Make sure that enough space is available for the installation of the system.
4. Plan and mark out the location of the unit and grilles before commencing
5. Before cutting holes for diffusers, check that the penetration is clear of ceiling joists, roof structure and electrical cabling or plumbing.
6. For optimum performance, please ensure the house is well insulated and does not have open penetrations into the ceiling.
7. Keep all the duct runs to minimum and avoid tight bends.
8. Acoustic ducting (Silentflex) should only be used on the supply and exhaust sides (not the return and intake lines).
9. For optimum performance, please consider using maximum of 5 supply outlets for house floor area not more than 280m<sup>2</sup>
10. The G3 pre-filter must be cleaned or replaced every 9 months or when necessary.
11. Isolate electrical supply before commencing any electrical work.
12. For return ducts located in open plan living rooms with inadequate kitchen extraction, or with smokey log burners, we recommend a pre-filter (see over page)
13. In colder areas an auxiliary inline duct heater is recommended (see over page)

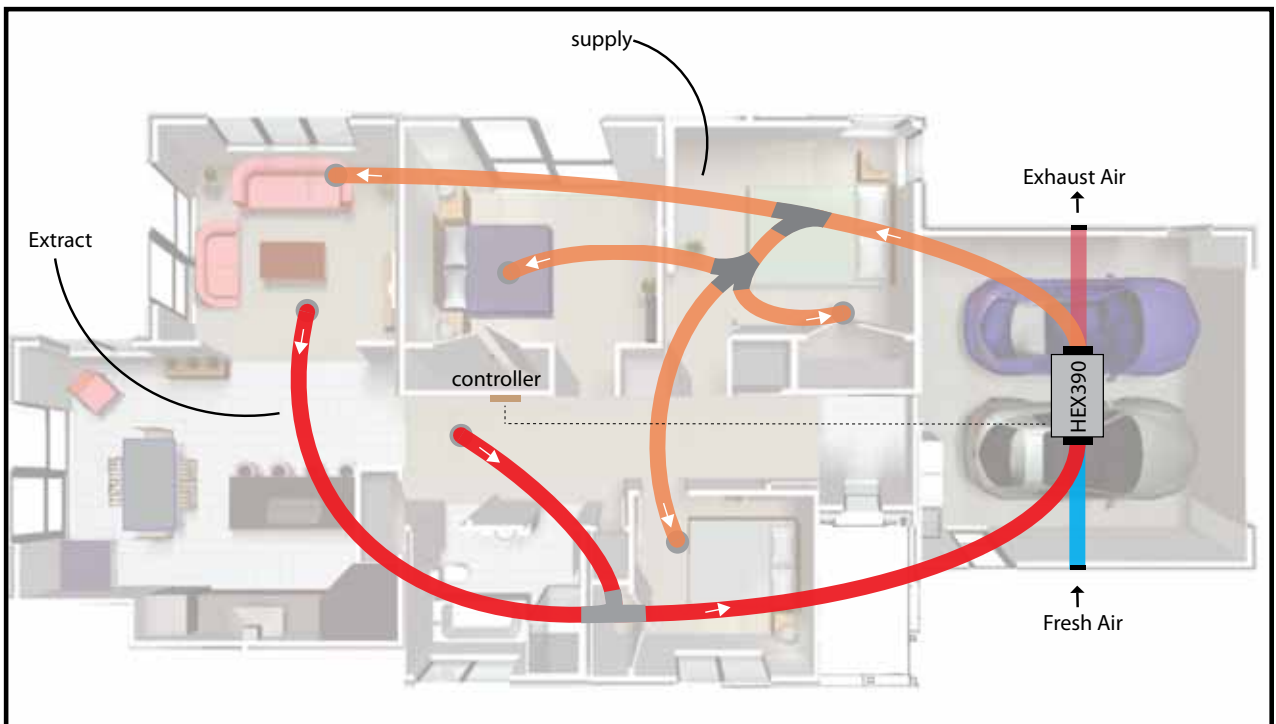

# Technical Data

HEX390 unit	
Air Flow (max)	390 m <sup>3</sup> / hr (110 l/s)
Sensible Effectiveness (max) (approx)	80%
Dimensions (mm)	400 x 400 x 850
Weight	20.75 Kg
Filter (replaceable)	EU3
Duct connection equivalent diameter	200 mm
Electrical	
Rated Voltage	220-240 VAC
Rated Wattage	240W
Fan Fuse	2A Ceramic Slow Blow
Controller Fuse	1A Ceramic Slow Blow
Heater Fuse	10A Ceramic Slow Blow
Diffusers & cut out size	
	Cut out size
Lounge supply (200mm Swirl Diffuser)	222mm
Bedrooms supply (150mm Cone Diffuser)	180mm
Return (200mm Circular Egg-Crate)	262mm
Fresh air / Exhaust (200mm Square Louvre)	
Optional Extras	
Item	Code
F7 Filter	FBPF7
Filter Box for F7 filter	FBP200
Additional 150mm supply	HEXext150supply
Additional 200mm supply	HEXext200supply
Additional Extract	HEXext200extract
750W heater (up to 180sqm)	HT
1500W heater (up to 280sqm)	HT15D



200mm Swirl Diffuser  
- lounge supply



150mm cone diffuser  
- bedroom supply



200mm circular eggcrate  
- return

# Kit Contents

	Hex390digi	Hex390man	HEX4roomkit	HEX3roomkit	HEXext150supply	HEXext200supply	HEXext200extract
<b>HEX Exchanger Body</b>	1	1					
16mmx 5m drain tube and fitting	1	1					
Digital controller Kit	1						
Manual controller kit		1					
Hanging wire and fittings	2	2					
<b>Supply</b>							
200mm swirl diffuser + Adaptor			1	1		1	
150mm circular cone diffuser			3	2	1		
200mm x 6m Silentflex			1	1			
200mm x 3m Silentflex			2	2		1	
150mm x 3m Silentflex			3	2	1		
200/200/200 'Y' connection			1	1		1	
200/150/150 'y' connection				1			
150/150/150 'Y' connection					1		
200/150/150/150 Branch			1				
<b>Extract</b>							
200mm Egg crate circular grille			2	1			1
200mm x 6m insulated duct				1			
200mm x 3m insulated duct			3				1
200/200/200 'Y' joint			1				1
<b>Fresh</b>							
200mm square Louvre Grille			1	1			
200mm x 6m nude duct			1	1			
<b>Exhaust</b>							
200mm square Louvre Grille			1	1			
200mm x 6m Silentflex			1	1			
<b>Components</b>							
6m Tape					1	1	1
50m Tape			1	1			

# Installation Instructions

## General Layout

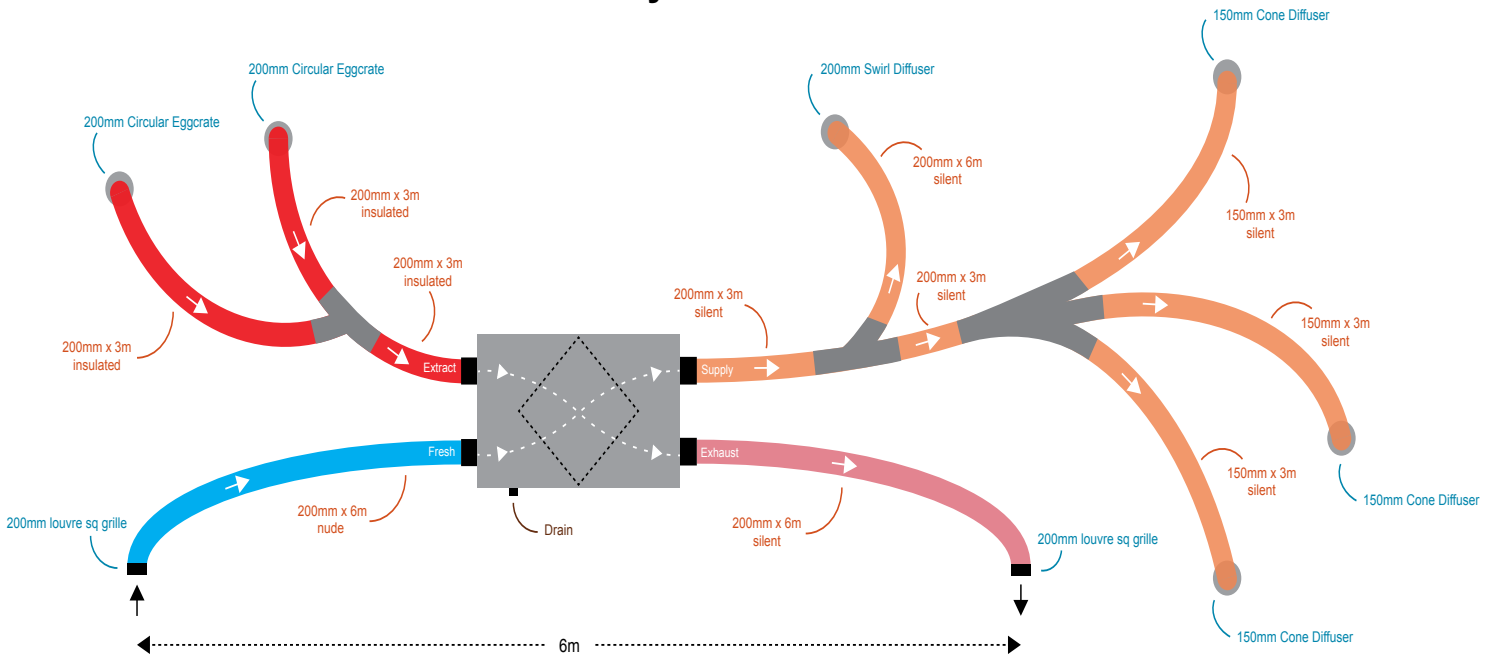

### Hex Unit

It's best to install over the bathroom, garage or similar location where occupancy is minimal and also where the unit could be easily accessible for servicing. Securely install the unit horizontally by using the provided installation kit as illustrated below. Ensure enough space is provided for the installation of the condensation drain adaptor and tubing (located inside the unit). Once duct and fittings connected, unit needs to be level for drain to work properly.



### INSTALLATION

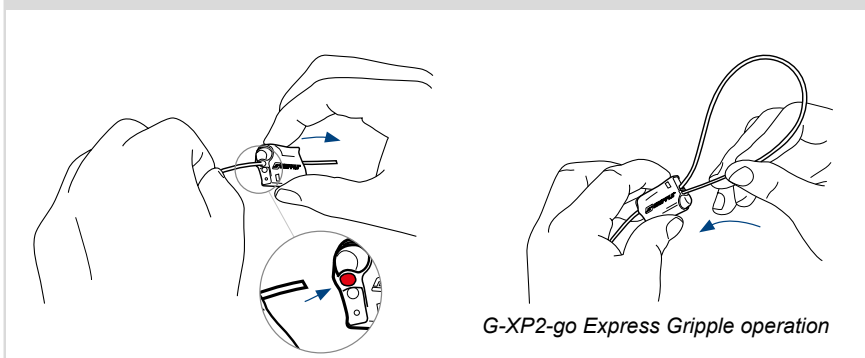

### RELEASE

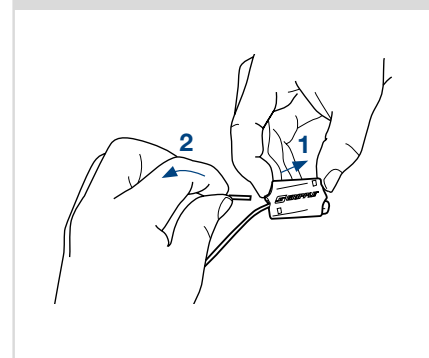

### Drain installation

Securely attach the provided drain adaptor (located inside HEX filter cover) to the bottom of HEX unit. HEX unit must be level. Run the drain tubing from the adaptor to outside with a "P trap", as illustrated.

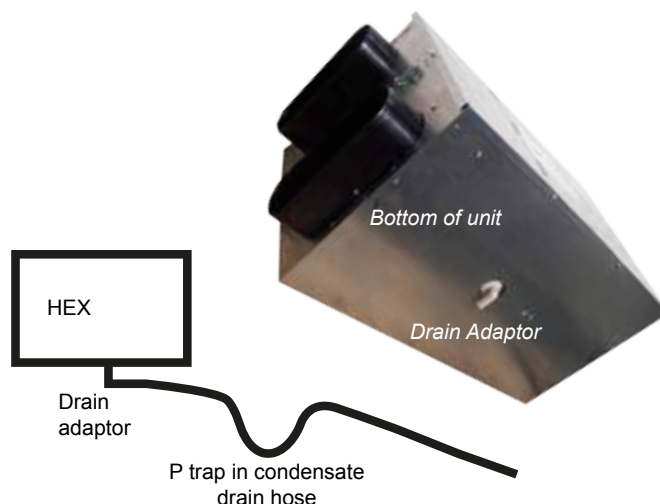

### Fresh Air and Exhaust Grille

Install underneath the soffit with a minimum 6m separation between the exhaust and fresh air grille to prevent cross contamination. Use the nude and acoustic ducting (Silentflex) from the fresh air and exhaust grilles respectively to the unit. If access is limited, please consider using through roof cowls, such as the MAD204T.

### Return Grilles

Mount the provided return air grilles as suits the homeowner, one in the heat source room and one in the hallway central to the supply grilles. Use the Insulated ducting from the grille to the unit.

### Supply Grilles

Mount the provided supply air grilles as suits the homeowner, bedrooms and living areas, with a maximum of five outlets for optimum performance. Use the acoustic ducting. It is recommended that the supply outlet be between these grilles and the unit.

### Filters

The unit is supplied with two G3 pre filters. If required, an F7 filter (FBP200+FBPF7) can be installed in the supply side for extra filtration. Alternatively a standard EU2 filter can be used (FBP200+FBPF2).

### Cleaning the filters

The internal filters are designed as secondary filters (there should be extended surface filters cleaning the air before reaching the unit). However, when unit filters are heavily soiled, wash or replace the filter material with "HexFilter" (234x380mm) or "HexFilter 222" (222x380mm) for 2015 and earlier models.

To wash: use vacuum cleaner to remove excess dust, then wash in warm detergent treated water, keep filters flat or leave in frame to wash.

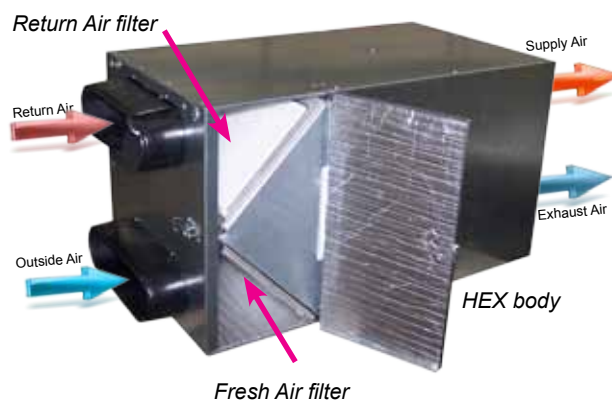

# Installation Instructions (continued)

## Attic control box

Attic box can be mounted on or near the unit.



HEX Attic box

Terminate separately the grey & brown wires from the HEX unit

## Wall Controller

Digital or manual 3 speed controller (located inside the attic box for transportation and storage), should be installed in the hallway or lounge, adjacent to one of the extract grilles.

## Digital sensor (for digital model only)

Placed into incoming fresh air flow, through the pre-drilled hole, and fixed with the cable tie.



Temperature sensor mounted in fresh air inlet

## In-line Duct Heater (for digital model only)

If installing HT or HT15, ensure the duct heater is securely installed horizontally and ensure the air flow meets the minimum required.

Cat5 cable to digital wall controller

Temperature sensor wire plugs in here



For digital controller, mount with pack glands downwards



### Internal on/off Thermostat - Digital Controller

The thermostat should be disabled for digital controller, as the digital controller should control all airflows.

### Internal on/off Thermostat - Manual Controller

(Optional) The internal thermostat (2core cable from the HEX unit) can be set so the unit turns off if the temperature exceeded the set point (eg if thermostat is set to 30, the unit will turn off if the incoming fresh air is above 30°C).

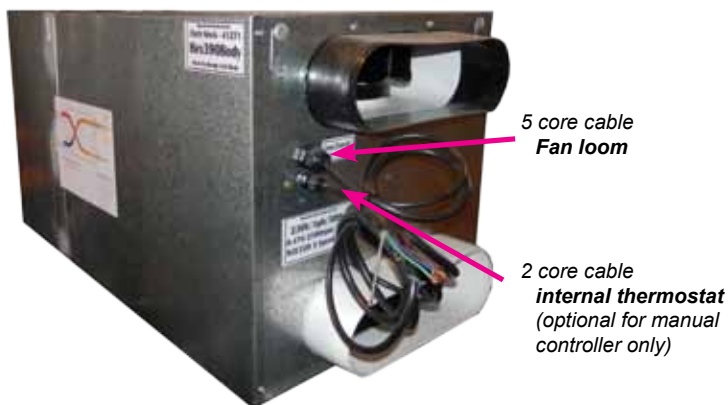
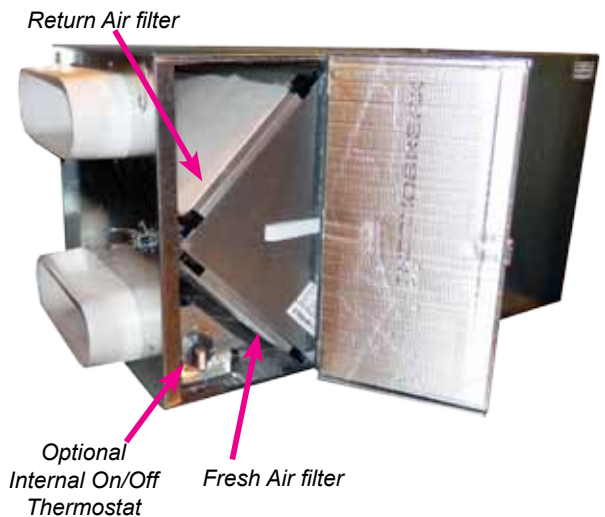

### Cables

The 5 core cable (fan loom) goes to the attic box, for both manual and digital versions.

The 2 core cable (internal thermostat) is optional for the manual controller - leave unconnected for digital version.

Hex Digital Controller Wiring Schematic

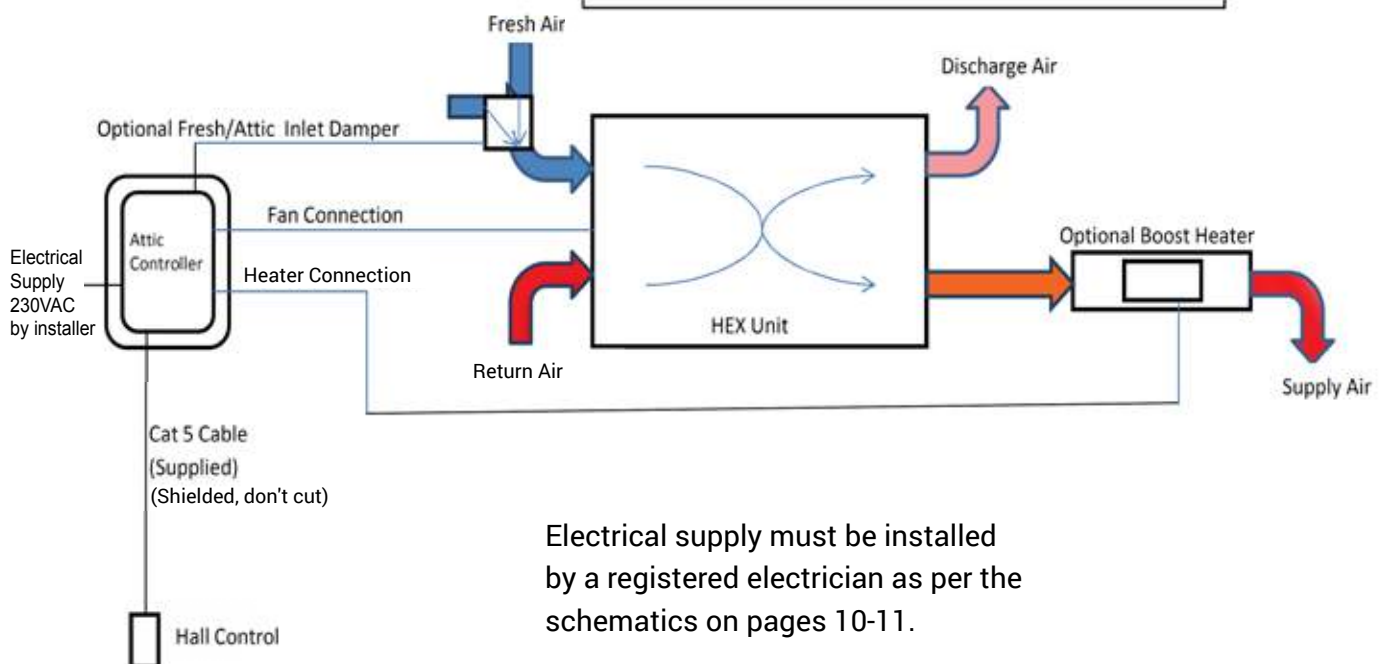

Electrical supply must be installed by a registered electrician as per the schematics on pages 10-11.

# Wiring schematic - Manual 3speed switch

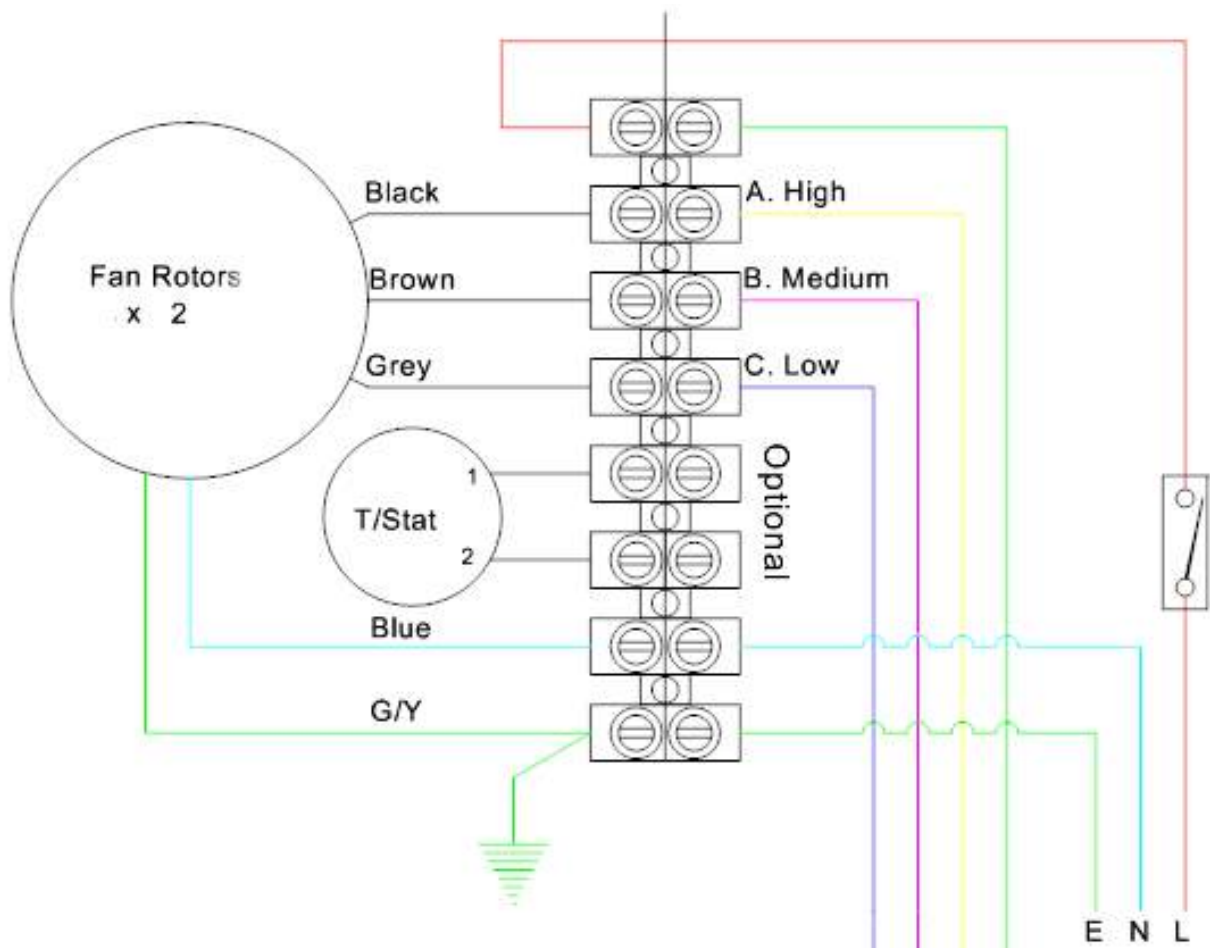

*The attic box also comes with a two core wire for use with the optional thermostat.*

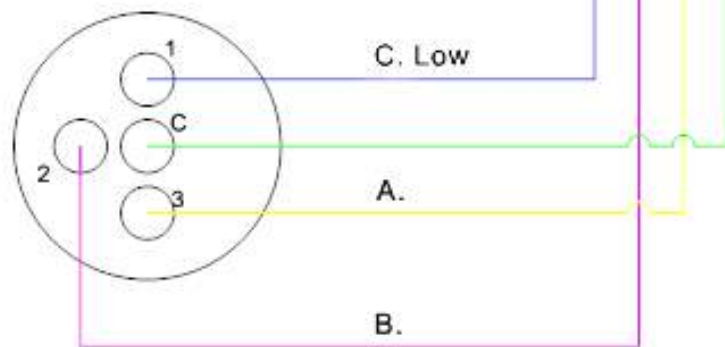

# Wiring schematic - Digital controller

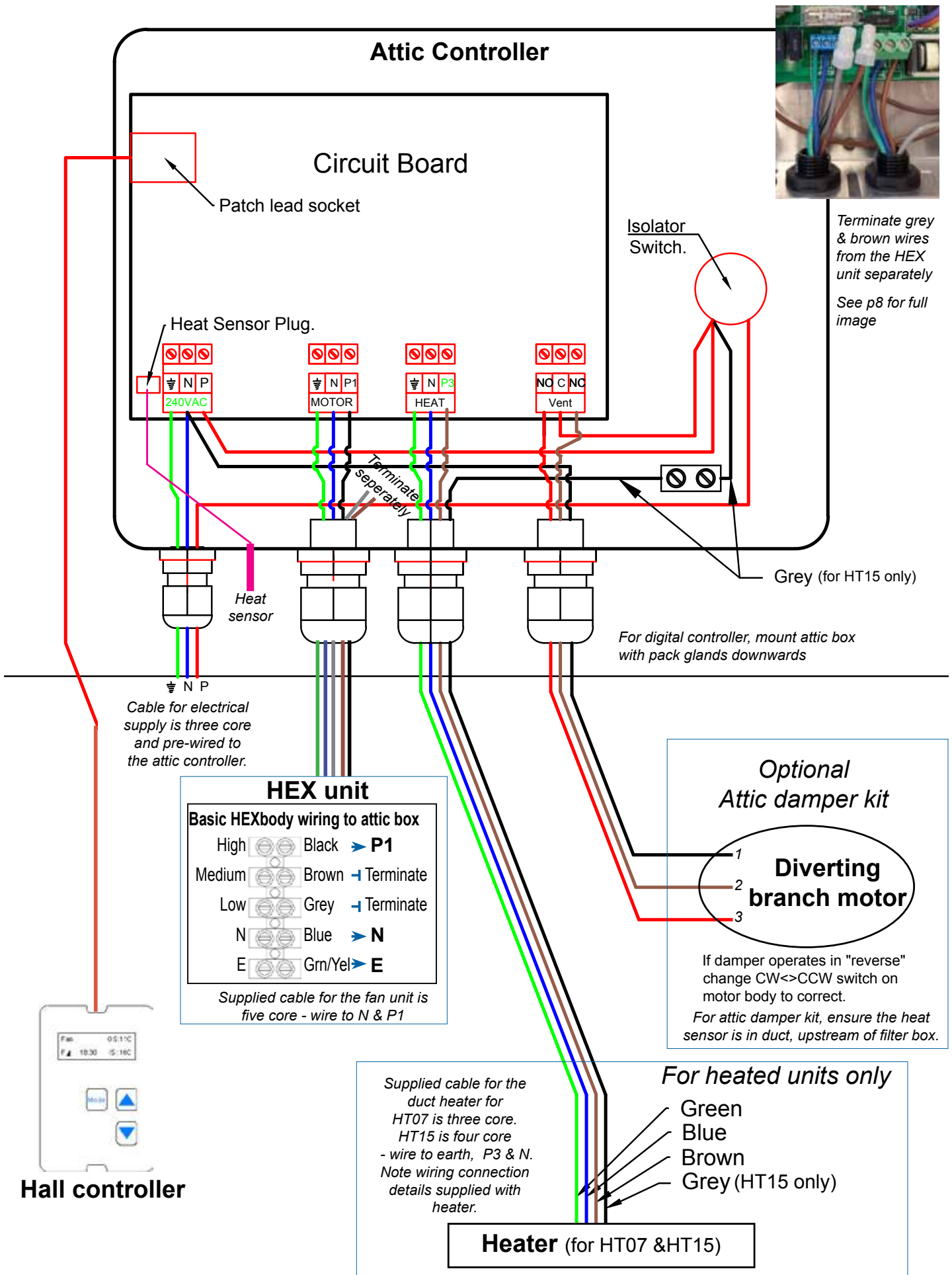

# Trouble Shooting

Symptoms	Solutions
Fans not operational	<ul style="list-style-type: none"> <li>• Check circuit breaker in the mains switch board</li> <li>• Check power to the hall controller. If hall controller is active, check the 2A fuse in the attic controller, after isolating the power to the unit.</li> </ul>
Fan too noisy	<ul style="list-style-type: none"> <li>• Check the Max Fan Speed setting match the recommended setting for the house size, lower the speed of fan if necessary</li> </ul>
Outside temperature incorrect	<ul style="list-style-type: none"> <li>• Set the correction in commissioning menu</li> </ul>
Inside temperature incorrect	<ul style="list-style-type: none"> <li>• Set the correction in commissioning menu</li> </ul>
Heater Fault	<ul style="list-style-type: none"> <li>• Check fans are operational</li> <li>• Check fan speed heat setting, increase the value if necessary</li> </ul>
Unexpected Filter Full notification	<ul style="list-style-type: none"> <li>• Check the setting in commissioning menu and adjust if necessary</li> </ul>

All electrical work must be conducted by a qualified electrician to NZ standards.

## Installer's recommended settings:

	Default	Installer recommended
1. Heater Kit	Yes	Yes / No
Heater ON	time: 19:00	..... : .....
Heater OFF	time: 07:00	..... : .....
2. Max Fan Speed	60%	....%
3. Fan Speed Heat	45%	....%
4. Winter Mode	Yes*	Yes / No
If Yes, shut down temp:	0 °C	....°C
5. Filter Timer	No	Yes/No
If filter timer Yes:	240 days	.....days
6. I/Side Ref Temp	18°C	....°C
7. O/Side Ref Temp	12°C	....°C
8. O/Side Degree Offset	0°C	....°C
9. I/Side Degree Offset	0°C	....°C
10. Heat P/band	5°C	....°C
11. Summer Temp S/down	27°C	....°C
12. User Sys	Off	On / Off
13. Factory Reset		
• Optional attic damper kit installed	No	Yes / No



\*some models Winter mode default is 'No'

NB: The attic damper kit option is always available on the main interface, but it does not affect operation if a damper is not installed

### Installer Details:

# Digital Controller - Commissioning Instructions

The Heat Recovery Digital Controller has a number of features available to customize the system to suit house size, layout and user preferences.

The Setup menu is accessed by pressing the  &  buttons together for about 5 seconds until the display reads 'Setup Menu'.

The controller comes preset with default factory settings, these can be reinstated using menu item 'Factory Reset' (number 13 on next pages). If the unit is not set up correctly to suit the house, performance may be reduced.

There are a number of options which can be scrolled through by pressing the Mode button  as below.



If no button is pressed within 15 seconds the controller automatically reverts to normal operation. Once a button is pressed a backlight will operate and remain on for 20 seconds after the last keystroke.

Press  button to toggle between Yes/No or other options, then press 'Mode' to advance through the menu. Once a setting is changed on the menu, it is automatically registered.

Hold down the 'Mode' key to accelerate through the menu,

Options are on following pages.

*Please note: if settings are changed from recommendations, performance of the unit may be reduced.*

-  Press up and down arrows together for 5 secs to get to Setup Menu
-  Use Mode button to scroll through options
-  Use up arrow to change

Display Key :

Δ - Outside Air Temperature

□ - Inside Air Temperature

Winter - winter mode is on

Wint off - winter mode has automatically shut the system off

H - Heater is fitted

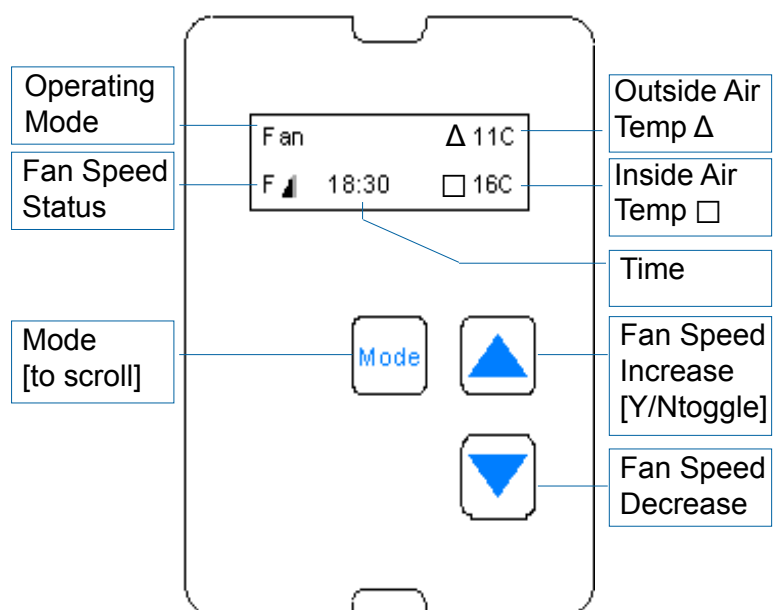

The following commissioning menu is for v3.1.762 .

Programme version number is written on the back of each board. The version number will also display when the device boots for the first time following any power outage.

# Digital Controller - Commissioning Instructions (continued)









## Digital Controller - Commissioning Instructions - Menu Options

### 1. **Heater Kit** Yes/No (default Yes)

If No - heater options are removed from all menus.

If Yes - heater options are available in User menu - Heater On/Off for continuous or night heat (to times as set below) .

To set night heat option:

- press  up arrow to select Yes, then:
- press  mode to display 'Heater Times' > display then changes automatically to show the current settings (default: Heater ON 19:00  
Heater OFF 07:00 ) > display changes again to 'Change Times' Yes/No (default No).
- At this point, use  then  to select Yes & change the times.
  - Select desired **Heater ON** time in Hours:Mins using  or 
  - Select desired **Heater OFF** time in Hours:Mins using  or 
- Heater Test Yes/No (default No)
  - change to Y, heater test will be performed. If there are any faults (including no heater connected), 'Heater Fault' will display. (See menu item 3. Fan Speed Heat for possible Heater Fault causes.) To reset Heater Fault display, turn unit off.



### 2. **Max Fan Speed** (default 60%) – Range is 35% to 100% adjustable in 1% increments using up & down arrows. For a large house set to a max of 100%.

House size	Max Setting
Upto 120m <sup>2</sup>	50%
120m <sup>2</sup> - 180 m <sup>2</sup>	70%
180 m <sup>2</sup> -250 m <sup>2</sup>	100%
280 +	Two or more units recommended

### 3. **Fan Speed Heat** (default 45%) – Range is 30% to 60% adjustable in 1% increments using up & down arrows.

**Fan Speed Heat** sets a minimum speed for the fan to ensure enough airflow for the heater to operate. There are many duct fan combinations, some more restrictive to airflow than others. Therefore, when setting up, the installer must check that the heater operates without 'Heater Fault' flashing on the display. 'Heater Fault' is triggered when the heater is operating but draws no current, this is most often due to insufficient airflow causing the airflow proving switch to cut off. If there is insufficient airflow, increase the 'Fan Speed Heat' setting. Heater fault may also be caused by manual reset thermal cutouts which may need to be reset.

### 4. **Winter Mode** Yes/No (default Yes). Winter mode shuts the system down when the outside air temperature gets below eg 2°C. If Winter Mode is on, another menu item will appear to allow adjustment of actual shut down temp: Range -2°C to +5°C.

5. **Filter Timer** Yes/No (default No) – Controller counts hours run by the fan and when filter is due for a change the display flashes with ‘Swap Filter’. If filter timer is set to ‘Yes’, another menu appears allowing filter period adjustment (240 day) (range 150 - 240 days). The filter timer can be reset in the user menu at any time. The timer should be reset after the filters have been cleaned or replaced.
6. **I/Side Ref Temp** (default 18°C) Range 16-24°C. This is the reference temperature for the inside of the house, used for:
  - Heating – when house temp (IS) is lower than 18°C (default) and outside temp (OS) is lower than 12°C (default) the heater will operate (if fitted).
  - Summer – when house temp (IS) is higher than 18°C (default) and outside temp (OS) is higher than 27°C (default) the unit will shut-down.
7. **O/Side Ref Temp** (default 12°C) Range 8-16°C. This is the reference temperature for the outside air, below which heater operates (if fitted).
8. **O/Side Degree Offset** (default 0°C) this allows unit to be calibrated in the unlikely event that outside air temperature reads too high or low (adjustment range -10°C to + 10°C).
9. **I/Side Degree Offset** (default 0°C) - As above.
10. **Heat P/band** (default 5°C) Range 1-7°C. Heat Proportional Band - When heater is fitted and conditions call for its operation, heater will start heating at 20% when OS (outside) drops to reference temp (default 12°C), and will operate at 100% when temperature has dropped by a further (default) 5°C (ie when OS is 7°C).
11. **Summer Temp S/down** (default 27°C) Range 25°-35°C. When OS (outside temp) is greater than 27°C and IS (inside temp) is greater than 18°C, the system shuts down.
12. **User Sys** Yes/No (default No) - when set to ‘Yes’, there is an option in the User menu to turn the system On/Off. Once the system has been turned off, any key may be pressed to return the unit to regular operation.
13. **Factory Reset** Yes/No (default No). ‘Yes’ resets all menu items to the factory default settings, these default settings are shown in brackets above. This option will ask for confirmation to ‘Erase Settings?’ before performing the factory reset.
  - **Optional Attic Damper Kit.** A diverting branch can be attached to divert the intake from outside air to the attic to utilise the heat gain from roof during winter months. Press mode  and  up arrow together until ‘DamPer is on’ or ‘DamPer is off’ displays. The user can then select between ‘Change damPer? YES’ or ‘Change damPer? NO’ then displays. Use the up arrow to change between the two settings and press the mode key to select.

# User Operating Instructions

## Manual Controller

This unit has High / Medium / Low speeds which the homeowner can use to regulate the fresh air amount to suit the load. The 3 speed switch has four settings: Typically:

- 3 - High** - where a number of people are living in the house and/or outside temperatures are moderate
- 2 - Medium** - less people in the house and/or colder outside temperatures
- 1 - Low** - mainly to keep air fresh in the home during extremely cold conditions.
- 0 - Off**



3 speed switch







## Digital Controller

This digital controller allows the user to adjust fan speed from high to low (fan limits are set in the commissioning menu to suit the size of house and system layout).

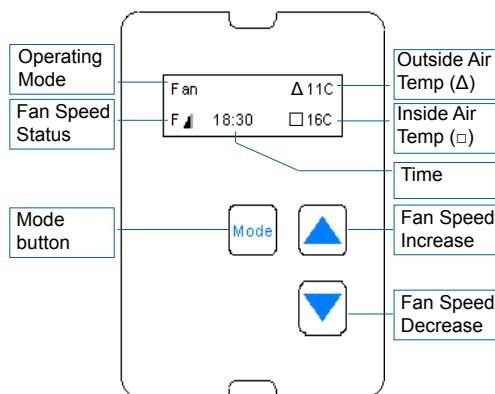
The controller will automatically shut down in summer if outside air temperature ( $\Delta$ ) exceeds 27°C and the home is warm.

There are a number of other features available at time of installation which will need to be discussed with the installer when the unit is commissioned (see Digital Controller Setup instructions p6-9). They include:-



- **Optional supply air boost heater** (when heater fitted) is controlled automatically when outside air temp ( $\Delta$ ) is less than 12°C and home is cold. This is indicated by “H” with bar symbol in the unit display. Heat is controlled over a proportional band so that as  $\Delta$  gets colder, heater output increases to maximum.
- **Optional winter off mode** shuts down the fan automatically when outside temperature ( $\Delta$ ) is less than 2°C. This is indicated by “Wint off” on the unit display.
- **Optional User System On/Off** is available in User Menu, indicated by “OFF” on unit display. Press any key to return the unit to regular operation.
- **Optional Filter Timer** measures the hours run by the fan and gives a flashing display when the filter needs to be cleaned/replaced.
- **Clock function** has battery back-up in the event of a power failure. Time can be set/adjusted by pressing mode  and  buttons together until “Entering Menus” then “Set Clock” appears. Time can then be adjusted using up & down buttons, once correct time is set, press “mode” to save new setting.
- **Optional Attic Damper Kit.** A diverting branch can be attached to divert the intake from the outside air to the attic, to utilise the heat gain from the roof during the winter months. Press mode  and  up arrow together until ‘Damper is on’ or ‘Damper is off’ displays. The user can then select between ‘Change damper? YES’ or ‘Change damper? NO’ displays. Use the up arrow to change between the two settings and press the mode key to select.

**To get to User Menu:** press and hold mode button, continue holding while until “User Setup” shows.

Use the up arrow to change the options, Mode button to select.



Digital controller